

# GSatSolar User Manual

## Table of Contents

<b>Document Version</b>	<b>3</b>
<b>Introduction</b>	<b>4</b>
Purpose	4
References	4
Websites	4
Documents	4
Activation	4
Description	5
Block Diagram	5
<b>GSatSolar Best Performance</b>	<b>6</b>
Mounting Best Practices	6
Antenna Orientation	6
Temperature	6
Solar Panel	6
Noise Sources	6
<b>GSatSolar Mounting Options</b>	<b>7</b>
Clip	7
Strap	7
Adhesive / VHB	7
<b>GSatRancher Mounting Options</b>	<b>8</b>
Ear Tag	8
Mounting Instructions	8
Ear Tag Removal	11
Strap/Collar	12
Mounting Instructions	12
Primary Strap/Collar Option:	12
Connecting Strap Option:	12
<b>Identification Features</b>	<b>13</b>
<b>Theory of Operation</b>	<b>14</b>
<b>Functional States</b>	<b>16</b>
Pre-Operational State	16
Activating Mode	16
Operational Modes	16
<b>Tracking Modes</b>	<b>17</b>
Standard Tracking	17
Standard Motion Tracking	17
Dock Mode Motion Tracking	17
<b>Location Transmission Behavior</b>	<b>18</b>
<b>Health Status Message</b>	<b>19</b>
Health Status Message Content	19

<b>End Of Service</b>	<b>19</b>
<b>Technical Specifications</b>	<b>20</b>
Certifications	20
Overview	20
Battery Specifications	20
Solar Panel Performance	21
Battery Performance	21
GPS Performance	21
Flash Memory	22
Material Specifications and Certifications	22
Other Specifications	25
<b>General Warnings</b>	<b>26</b>
Product Maturing	26
<b>Regulatory</b>	<b>27</b>
Radio Astronomy Site Avoidance	27
Regulatory Notices	27
Additional Notices	27
<b>Appendix A</b>	<b>29</b>
Acronym List	29

## Document Version

20211004 V1.0.0	Initial Document
20221012 V1.0.1	Added Battery Performance
20230801 V1.0.2	Added note on the aging process
20230803 V1.0.3	Added Material Specifications and Certifications
20241023 V1.0.4	Updated terminology for wireless connections. Minor grammatical fixes

RESTRICTIVE EXPORT NOTICE – This document may contain technical data whose export is restricted by the Export Administration Act of 1979, as amended, Title 50, U.S.C., App 2401 et seq. Violations of these export laws are subject to severe criminal penalties. Disseminate only in accordance with such export laws.

Published and printed in the U.S.A. by:

Global Satellite Engineering, Inc  
2429 SW 44th Terrace  
Fort Lauderdale, FL 33317

Copyright © 2023 Global Satellite Engineering, LLC. All rights reserved.

GSatSolar® is a registered trademark of Global Satellite Engineering, Inc. All other brands, product names, trademarks, and registered trademarks are properties of their respective owners. This material may not be reprinted, republished, broadcast, or otherwise altered without the publisher's written permission. This manual is provided without express, statutory, or implied warranties. The publisher will not be held liable for any damages caused by or alleged to be caused by the use, misuse, abuse, or misinterpretation of the contents. Content is subject to change without notice.

# Introduction

## Purpose

This document describes the physical, electrical, and functional characteristics of the GSatSolar Series satellite transmitter module. It is intended to provide the customer with the technical information required to configure and use the module.

## References

### Websites

- [www.gsatsolar.com](http://www.gsatsolar.com)
- [www.gsatrancher.com](http://www.gsatrancher.com)
- [www.gsattrack.com](http://www.gsattrack.com)

### Documents

[GSatSolar Series Quick Start Guide](#)

GSatSolar App User Guide

- [iOS](#)
- [Android](#)

## Activation

To activate your new device, please see the GSatSolar Series Quick Start Guide and the GSatSolar App User Guide.

## Description

The GSatSolar Series is a Satellite transmitter designed to send GPS location data to a network of low earth orbiting (LEO) satellites. The received data is then delivered to a telematics platform or other processor to visualize and utilize the data. A rechargeable battery powers the GSatSolar, which features a solar charging circuit that allows battery charging from the built-in solar panel. The GSatSolar Series contains a satellite transmitter, GPS receiver, motion sensor, wireless transceiver, solar charger, and antennas for each radio subsystem.

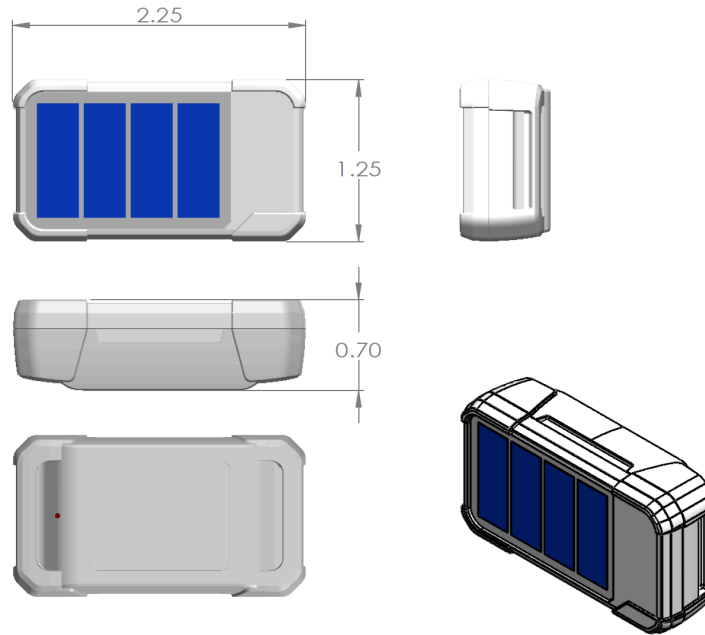
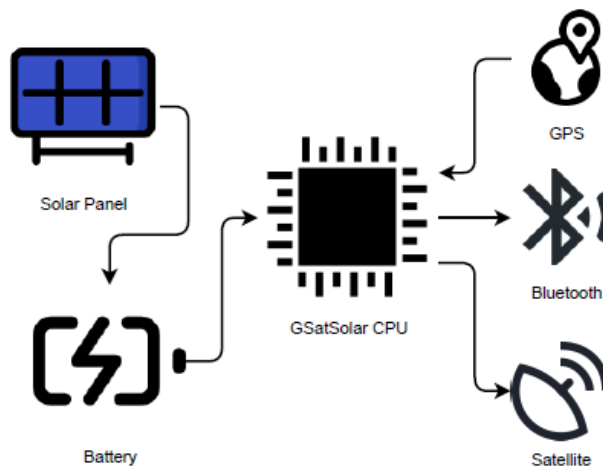

Figure - Physical Dimensions (inches)

## Block Diagram



# GSatSolar Best Performance

The GSatSolar Series determines its location by triangulation of GPS satellites and then transmits the location back to a communications satellite. It is important to understand the application and importance of good satellite coverage, and outdoor locations, and take into account obstructions, buildings, and metal objects that greatly affect the antenna performance. These devices are transmitting a signal up to 1,000 miles. Even though they are small and lightweight with the latest silicon technology, they are still sensitive to positioning and orientation much more than say a cellular phone, which is transmitting up to a few miles.

## Mounting Best Practices

### Antenna Orientation

Care should be taken as to what is placed above, below, and around the GSatSolar Series. The internal satellite antenna is located inside the top edge of the GSatSolar Series. For best performance, the GSatSolar Series should have an unobstructed view of the sky. Metal objects next to or above the GSatSolar Series will greatly affect the performance of the device. Non-metallic substances such as fiberglass and plastic have less effect on the antenna performance.

### Temperature

 DO NOT MOUNT ON BLACK SURFACES. OVERHEATING RISK IS INCREASED

The GSatSolar Series utilizes an internal lithium polymer battery, which is designed for operation between -10C and +60C. In direct tropical sunlight, the solar panel will also heat the unit by up to +15C from ambient temperature. In winter months, the additional heating caused by the solar panel will help increase the internal temperature of the unit, but in the desert, this can cause overheating and the unit will cease transmitting if the internal temperature exceeds these temperatures. The unit will resume operation once the temperature has dropped below the maximum operating temperature.

In general, do not mount on:

- Black surfaces
- Metal surfaces
- Poorly ventilated locations
- Car dashboards
- Enclosed locations that trap heat

### Solar Panel

The orientation of the solar panel is important to consider, to ensure the device is mounted where direct sunlight will hit the solar panel. Placing the device under plastic or glass is not ideal, as different materials can block UV which is a large portion of the spectrum that the solar panel is most effective at converting to energy.

### Noise Sources

Electrical noise is an important consideration in any installation of the GSatSolar Series. When possible, sufficient physical separation should be maintained between electrical noise sources and the GSatSolar Series. Noise sources can be any other transmitter such as other satellite devices, GSM, WiFi, etc.

# GSatSolar Mounting Options

## Clip

The clip can be mounted to a surface with

- Screws
- Strap
- VHB
- Adhesive

To attach, press the GSatSolar Series into the clip until you hear a firm snap on both sides.

To detach, use the indent in the clip arms to release one side of the GSatSolar Series, then release the other side.

**⚠ NOTE:** The clip is designed to hold the GSatSolar Series very firmly. It will take significant force to remove the GSatSolar Series.

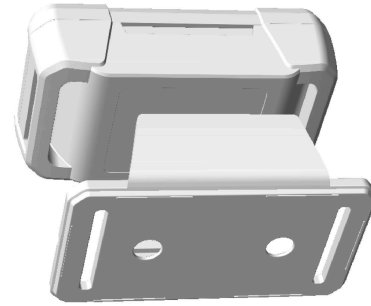

## Strap

- Insert a nylon strap through the rails on the top and bottom side of GSatSolar as shown in the diagram.
- A second option is to use two nylon straps and one nylon strap for each side in a U shape.

If you are using the strap design for an application that will exert a large amount of force on the strap, it is recommended to use a stronger strap and/or collar and rivet the smaller strap to the larger strap to increase the strength.

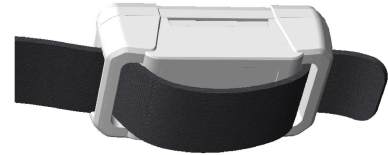

## Adhesive / VHB

**⚠ NOTE:** Using adhesive on the rear of the GSatSolar Series can damage the QR code and/or other information printed on the back of the case. It is recommended to take a picture of the rear of the unit before applying an adhesive

1. Prepare the surface of the GSatSolar Series, and the mounting surface, by cleaning with isopropyl alcohol.
2. Use 3M VHB tape to adhere the unit to a surface OR use an adhesive appropriate for your application

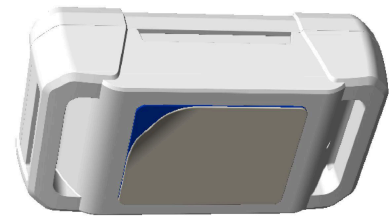

# GSatRancher Mounting Options

## Ear Tag

**!** NOTE: The ear tag components are clear plastic, not blue, as shown in the example. The computer-generated image uses color to help the user clearly identify each component.

### Components of the ear tag

1. Male Pin: Pin for piercing the ear
2. Mounting Strap
3. Female Socket: Must be mounted in Mounting Strap #2  
Note: The flat side of the female socket faces the back of the GSatRancher, and the raised side faces the solar panels.

### Tools necessary for installation

1. Crimping Tool
  - a. Allflex Universal Total Tagger
  - b. (or) Most universal taggers will work
2. GSatRancher
3. GSatRancher Ear Tag Mount (3 parts)

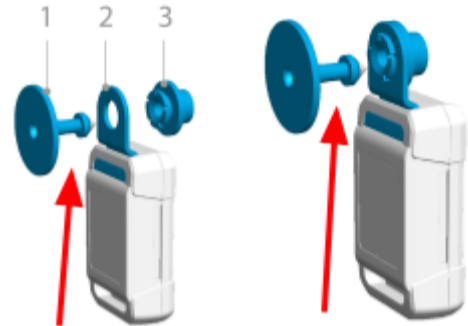

**NOTE: Animal's ear goes between Male Pin and Female Socket**

Unassembled

Ready for Installation

## Mounting Instructions

**!** NOTE: Vets have indicated that piercing and rubbing can cause infection. Use proper disinfectant to clean the area on both sides of the ear and the ear tag components before application.

**!** NOTE: The application site must be free of foreign debris before the placement of tags on the animal. Free Air Space is critical for proper healing and retention. Inspect placement after tagging to ensure there is sufficient space between the ear and the tag.

**STEP 1:** Pull the Mounting Strap through the top rail of the GSatRancher

The Mounting Straps are difficult to pull through at room temperature and need to be temporarily soaked in warm water before attaching to the GSatRancher. Use the following steps:

1. Set up a pot of warm water (70C or 160F). Don't use hot/boiling water, it will deform the Mounting Strap above 90C or 190F.
2. Thread a string/cord through the Mounting Strap. Use a 1mm cord or similar for this process.
3. Drop the Mounting Strap into the warm water for 30 seconds.
4. Thread the ends of the string through the top rail of the GSatRancher.
5. Pull the string through the top rail and the Mounting Strap will pull through with it quite easily.
6. Remove the thread from the Mounting Strap.

Using dish soap to attach the Mounting Strap to the GSatRancher is an option as well:

1. Thread a string/cord through the Mounting Strap. Use a 1mm cord or similar for this process.
2. Apply a drop of dish soap or dishwashing liquid to the Mounting Strap.
3. Thread the ends of the string through the top rail of the GSatRancher.
4. Pull the string through the top rail and the Mounting Strap will pull through with it quite easily.
5. Rinse off the Mounting Strap with room temperature water and remove the thread from the Mounting Strap.



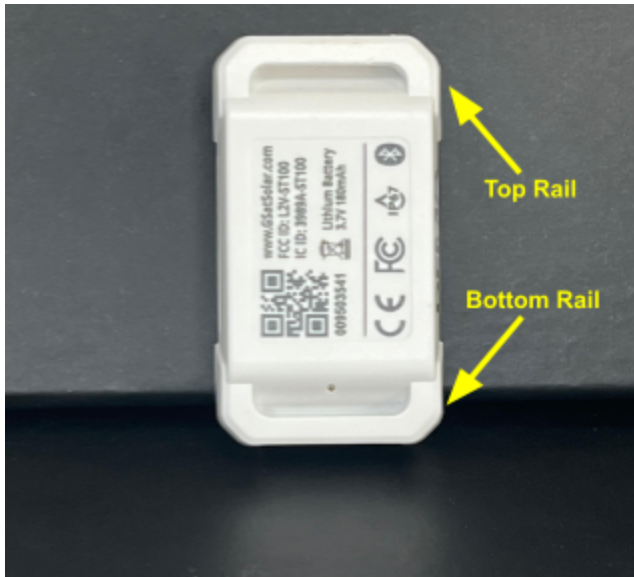

1. Slide the round end of the Mounting Strap under the top rail of the GSatRancher.

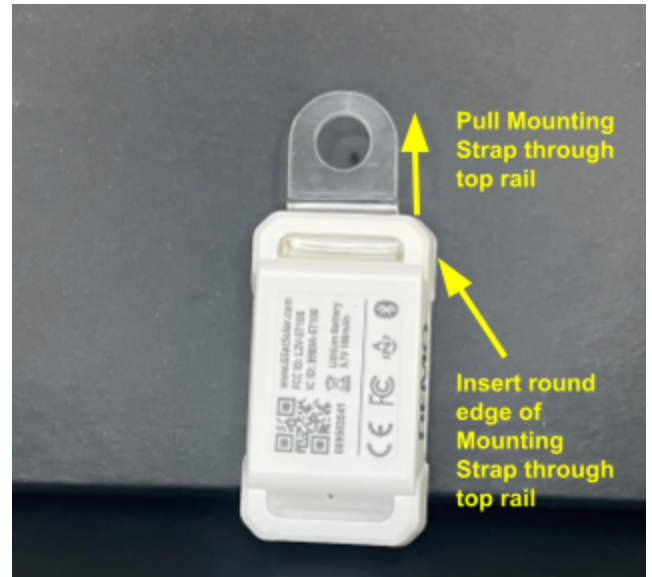

2. Firmly pull the Mounting Strap through the top rail of the GSatRancher until you hear a click or snap.

**STEP 2:** Firmly insert the flat backside of the Female Socket through the Mounting Strap.

**⚠ NOTE:** If the Female Socket is not properly mounted the GSatRancher can and likely will fall off the Male Pin. Make sure this step is completed properly.



1. Make sure the Flat Side of the Female Socket is facing the backside of the GSatRancher (away from the solar panels).

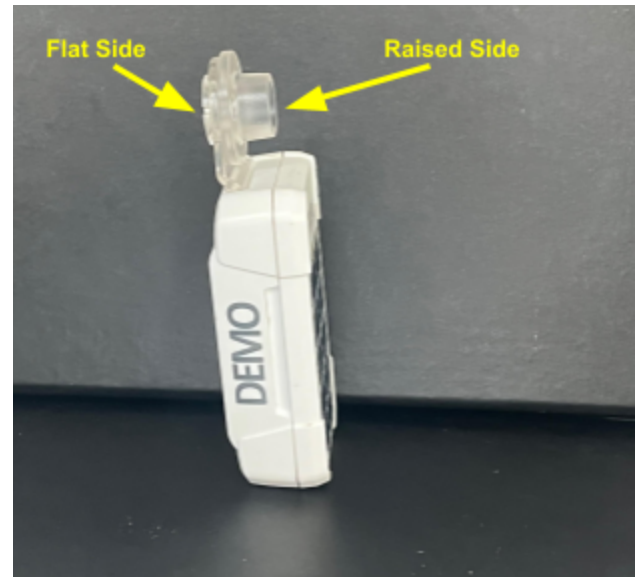

2. If the Female Socket is installed backwards the GSatRancher will not be properly mounted and will likely fall off.

**STEP 3:** Attach the Ear Tag components to the crimping tool.



1. To load, depress the spring clip and insert the Female Socket connected to the Mounting Strap and GSatRancher. Ensure that the raised portion of the tag is placed in the open portion of the jaws. The solar panels should be face down.

2. Slip the Male Pin completely onto the blunt applicator pin. Squeeze the jaws together lightly to ensure the Male Pin shaft is in line with the Female Socket.

3. Dip the jaws of the applicator holding the tag into an antiseptic or disinfectant solution.

**STEP 4:** Mount the tag onto the animal's ear.

**!** NOTE: A fake ear has been used in some of the images for demo purposes.



1. The tag should be placed vertically, in the middle of the ear, between the two cartilage ribs, and 2/3 from the outside edge of the ear, 1/3 from the head. (Application too deep in the ear is not recommended).



2. Make sure the GSatRancher is on the outside of the ear with the solar panels facing toward the sun. See additional images below.



3. The female portion of the tag should be on the outside of the ear with a tag application.

## Ear Tag Removal

**!** NOTE: Use an ear tag removal tool that has a plastic hook and guarded blade designed to prevent injury to the animal.

1. Carefully slip the hook between the male side of the tag and the animal's ear.
2. Place the hook around the stem of the tag.
3. Gently pull on the hook while moving it up and down in a twisting motion. Pulling too hard can tear the animal's ear.
4. Let the blade slice through the stem.
5. Apply antiseptic to the hole in the ear to clean it and prevent infection.



## Strap/Collar

**⚠ NOTE:** Although the GSatRancher is lightweight, a heavier counterweight should be attached to the opposite side of the strap/collar to ensure the solar panels naturally stay facing the sun. If this is not done then the GSatRancher will eventually shift underneath the animal pointing the solar panels away from the sun.

## Mounting Instructions

### Primary Strap/Collar Option:

- STEP 1:** Insert a nylon strap through the rails on the top and bottom side of the GSatRancher.
- STEP 2:** Attach the counterweight to the opposite end of the strap/collar.
- STEP 3:** Attach the strap/collar to the animal making sure it is not too tight or loose.

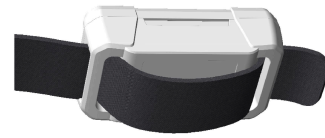

### Connecting Strap Option:

If you are using the strap design for an application that will exert a large amount of force on the strap, it is recommended to use a stronger strap/collar and rivet the smaller strap to the larger strap to increase the strength.

- STEP 1:** Cut two small straps long enough to wrap through the rails and connect to the primary strap/collar.
- STEP 2:** Carefully measure where the straps connecting straps sit on the primary strap/collar and cut two holes.
- STEP 3:** Insert the bolts from the bottom side of the primary strap/collar through the connecting straps and tightly secure the nuts on the top side. It is suggested to use washers to prevent wear and tear on the strap/collar over time.



1. Make sure the GSatRancher is not loose on the primary strap/collar. It should not be extremely tight as this may cause the secondary straps to tear over time, but too much room can allow the animal to get snagged on a tree branch or pointy object.

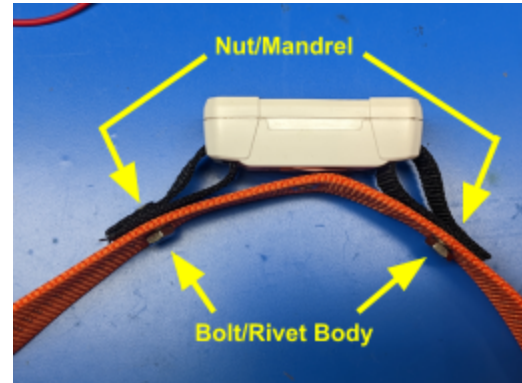

2. If using bolts, make sure the bolt is inserted from the underside of the primer strap/collar. For a rivet system, the body should be inserted from the underside of the primary strap/collar with the mandrel attached from the outside.

**STEP 4:** Attach the strap/collar to the animal making sure it is not too tight or loose.

## Identification Features

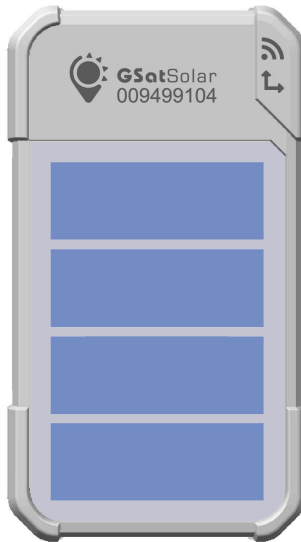

Front

ID: Printed on the front of the unit is a 9-digit number. The ID advertised wirelessly will be this ID without the leading zeros.



Rear

QR Code: Printed on the rear of the unit is a 9-digit QR code which represents the ID of the unit. This code can be scanned by mobile apps or any 2D scanners for quick identification.

# Theory of Operation

The GSatSolar Series operates on the Globalstar LEO satellite network. LEO (Low Earth Orbit) means that there are a number of satellites in low Earth orbit that constantly orbit the planet and can communicate with devices that are within range of their current position.

Because the satellite position is constantly changing, commercial IoT devices on the ground will transmit (with no knowledge of any of the satellites' locations) and the transmission may be received by one or more satellites. These satellites will then relay the message to the nearest satellite gateway. Once received by the satellite gateway, the message will be delivered to the gateway where redundant messages are discarded and the data from the message is sent to the telematics platform.

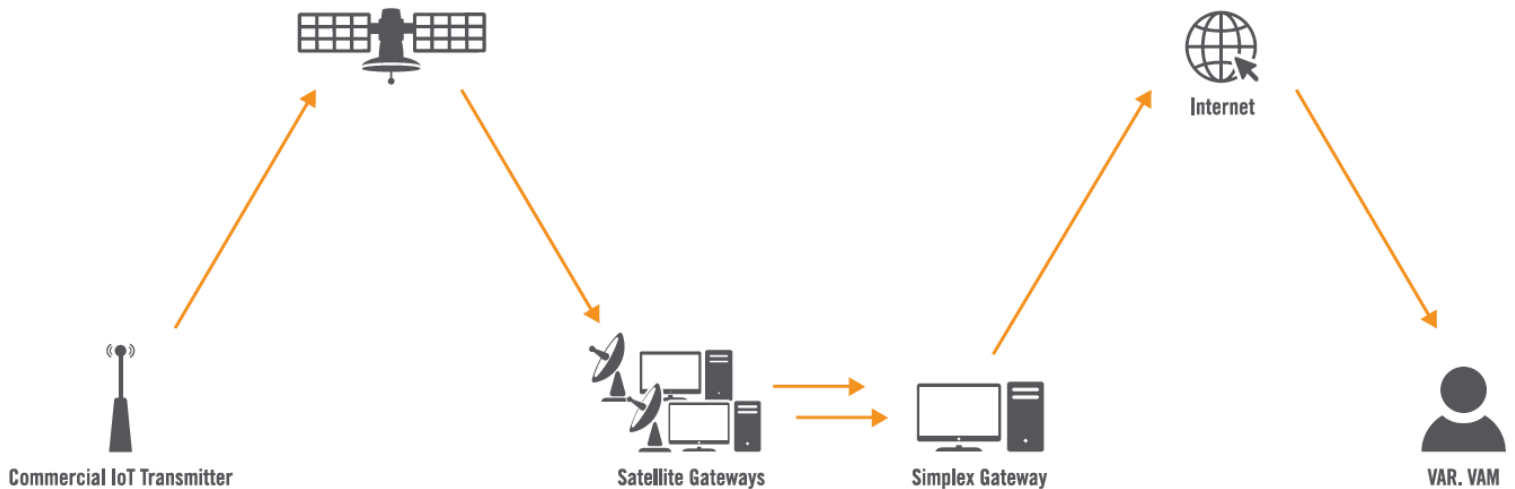
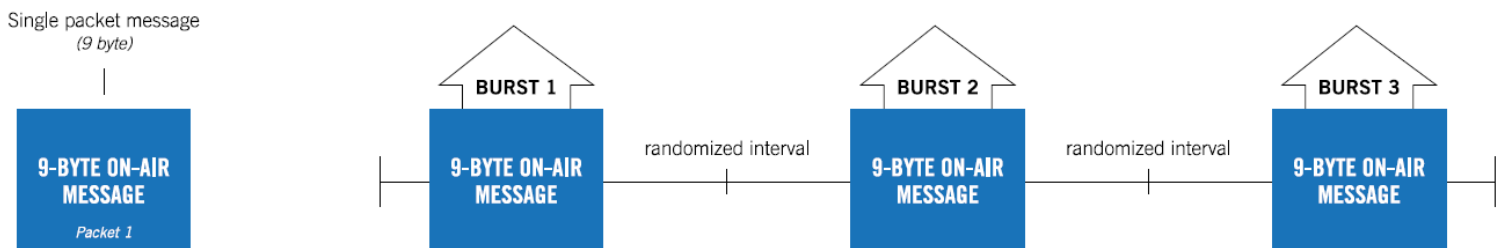

FIGURE - IoT MESSAGING

There are brief periods when there is no satellite in range of the commercial IoT transmitters due to obstructions and/or satellite coverage geometry. Since the GSatSolar Series has no way of knowing if a transmitted message has been successfully received, the GSatSolar Series is designed to send multiple (redundant) transmissions for each message sent.

The number of redundant transmissions per message is 3. This means that each message sent by the GSatSolar Series will be transmitted 3 times. Each transmission will contain the same data payload. The redundant transmissions of each message will be sent on a randomized interval with a configurable maximum and minimum duration. The default re-transmission configuration occurs between 5 to 10 minutes apart for each even randomized distribution. The transmission sequence for a single-packet message using 3 redundant transmissions is shown below.



For normal conditions where the transmitter has an open view of the sky, this will result in a better than 99% chance that the message will be received.



FIGURE - Simplex Coverage

# Functional States

Over the GSatSolar's/GSatRancher's lifetime, it transitions through the following states.

## Pre-Operational State

Note that these states are defined by events that have occurred before the device became fully operational.

- Configuration Mode: This describes the state in which the unit is shipped. No operational profile and no lifetime have been programmed into it. The unit's solar panel has not been uncovered and the battery has not been allowed to charge. The VAR transitions the unit to be staged for activation mode by setting a lifetime and a profile into the unit, as described in the section below.
- Staged for Activation: The device is considered to be in staged for activation mode when the following things have been programmed.
  - Device Lifetime: This is automatically selected at the time of activation based on the device and airtime plan selected
  - Reporting Rate / Profile: This is set using the activation portal and selection of an airtime plan, which subsequently is used to set and sync a profile to the device.
  - Low battery report rate: This is the report rate the GSatSolar Series drops to when the internal battery voltage is low (below 3.6 volts). The default is 24 hours (one transmission per day).

## Activating Mode

After the unit has switched to "Staged for Activation" mode, the unit enters the "Activating" mode when it detects that the unit is in sunlight and the battery is charging which is defined as a positive current flow into the battery for 5 consecutive minutes.

**NOTE:** A minimum amount of sunlight may be required for the solar panel to begin charging the battery, to enter the activating mode. If sunlight is not available (cloudy day), the device can be commanded to enter the activating mode via the mobile application.

Once charging of the battery is detected, the unit will attempt to obtain a GPS fix. If the fix is not obtained within the GPS timeout, the unit will sleep for 5 minutes and try again. This cycle will continue until a fix is successfully obtained. This cycle will "pause" if the battery level drops below 3.4 volts and resume after it has had some time to charge.

**NOTE:** If charging for 5 consecutive minutes is detected, the likelihood is extremely high that the unit is outside, and the GPS fix will be obtained on the first attempt. The retry cycle is an edge case exception in operation.

Once the unit obtains a GPS fix, it calculates its expiration date, based on the lifetime previously programmed, and enters operational mode.

## Operational Modes

These are the modes the unit may be in after completing the "activating mode" described above.

- Normal operation: Battery above 3.6 volts. The unit is in normal operation executing its track profile.
- Low battery operation: Battery between 3.6 and 3.4 volts. The unit will execute a track profile but at the reduced "low battery" rate.
- Extreme low battery suspends Battery below 3.4 volts. The unit will completely suspend operation, entering a "hibernate" state to allow the battery to charge.



# Tracking Modes

The GSatSolar series supports 3 tracking modes, which are detailed below.

**Accelerometer:** the GSatSolar Series contains a built-in accelerometer that can be used to detect motion to trigger position transmissions instead of a timer-based transmission cycle.

## Standard Tracking

Tracking reports are simply sent based on the defined interval between position transmissions. This mode does not use the accelerometer. The exact timing of transmissions is purposely somewhat randomized to guarantee successful transmission slots to the satellite network therefore over the lifetime of a unit, you will see the exact transmission time shift slightly per transmission.

## Standard Motion Tracking

In this mode, tracking reports are not sent when the device is not moving, and when the device is moving, tracking reports are sent based on the programmed reporting rate. The expected behavior is to receive no data if the device is not moving, except for the health reports.

## Dock Mode Motion Tracking

**NOTE:** This mode is not recommended for most applications as it consumes significantly more battery power vs simply increasing the reporting rate of the device. Please discuss this with your account manager before utilizing this mode to verify it fits your application.

To combine intelligent motion-based tracking with reduced position transmissions, this mode is ideal for assets that move while stationary. For example, a docked vessel on the water will trigger the motion-based tracking interval, but the vessel has not moved. This mode enables the GPS when motion is detected to verify whether the asset has moved, before transmitting. When multiple track points with similar GPS coordinates are detected, tracking will go into standby mode. While in standby mode the GSatSolar Series will not send track messages, but it will continue to attain your GPS coordinates at the same rate as your track mode. Once the GSatSolar Series has determined movement over a 200m distance, tracking will resume normally.

## Location Transmission Behavior

If the reporting interval is set to 30 minutes or greater, a redundant burst transmission will be initiated at each interval, with the number of attempts and the timing between the attempts as specified by the reporting rate. With an interval of 30 minutes or less, the GPS will retain its clock and ephemeris\* data to perform a “hot” GPS fix. This will increase the GPS standby current to the “GPS Standby Mode” value in the table below. For tracking intervals greater than 30 minutes, the GPS will be powered off in between transmissions and the sleep current will be the “Standby Mode” value.

If the interval is 40 minutes or greater, the GSatSolar Series will randomize the start of each burst by +/- 10 minutes around the nominal. For example, if a track mode with an interval of 1 hour is started at 12:00, the next burst position report will begin randomly between 12:50 and 1:10, the one after that will begin between 1:50 and 2:10, etc.

If the GSatSolar Series is in a motion detection mode, the accelerometer will remain powered during the standby periods in between transmissions and the accelerometer standby current will be the “Standby mode supply current w/Accelerometer” value. The following table summarizes the standby mode supply current for different modes.

**Table: Operating Modes and Standby Current**

Operating Mode	Standby Current
Continuous Tracking <= 30-minute interval	GPS Standby Mode + Standby mode supply current w/Accelerometer
Continuous Tracking > 30-minute interval	Standby mode supply current w/Accelerometer
Motion Activated Tracking <= 30-minute interval	GPS Standby Mode + Standby mode supply current w/Accelerometer
Motion Activated Tracking > 30 minute interval	Standby mode supply current w/Accelerometer

\*Ephemeris: a tabular statement of the assigned places of a celestial body for regular intervals.

## Health Status Message

The Health Status Message reports the current settings and condition of the device. The message generation interval is configurable from 1-30 days, with a default interval of 30 days. One message per month is generated at no charge, shorter intervals are charged according to the device plan.

NOTE: One message per month minimum, cannot be set to zero. The device health check message length is 2 packets (18 bytes).

## Health Status Message Content

- Number of Bursts per Message
- Battery Condition: Battery OK / Battery LOW
- GPS Status: GPS system OK / Fault
- Transmitter Status: Transmitter OK / Fault
- FW Version: Major FW / Minor FW / Patch FW Version
- Number of GPS Fails: Count of failed GPS attempts since last health message
- Number of Transmissions: Number of transmissions since last health message
- Mean GPS Fix Time: Mean time to get a GPS Fix since last health message
- Board Status: Board not reset since last health message / Board was reset since last health message

## End Of Service

All GSatSolar's and GSatRanchers are programmed with an end-of-service date to account for the expected life of the unit, and to ensure devices do not transmit after the end of their service plans. GSatRancher units are automatically programmed with an end-of-service equivalent to their service plan at the time of activation. For example, 4 reports per day for 3 years will set a lifetime of 36 months. For GSatSolar, the end of service is set to 5 years by default. If your application needs a different lifetime, please contact your account manager to discuss it. The end of service cannot be adjusted over the air, it must be performed locally wirelessly with the tag nearby.

When the unit auto-acts, it calculates an end date based on its programmed lifetime. For example, if the lifetime is 3 years (36 months) and it activates on October 24, 2020, the expiration date will be October 24, 2023.

Each time the unit obtains a GPS fix, it checks the calendar date. If the date is past the expiration date (in this example, October 25, 2023) it immediately drops out of track mode and enters the end of service mode.

Once the unit has entered end-of-service mode, it will respond over a local wireless connection to simple queries, such as a query for its version number or tracking state (which will be "none"), but it will NAK any command that might cause it to transmit over the Globalstar network.

# Technical Specifications

## Certifications

Our products comply with WEEE and RoHS. The GSatSolar Series has the following certifications:

- FCC
- IC
- CE

## Overview

- GSatSolar temperature range -20 to +65°C
- GSatSolar functional temperature range -20 to +65°C
- Battery charging temperature range -10 to +55°C
- Standby current: 30-40uA
- Battery current drain
- Standby current: 30-40uA
- GPS on current: 50-60mA
- Transmitter on current: 500mA max @ 3.7V
- Satellite RF output: +24.5dBm
- Supported Frequencies: 1611.25MHz, 1616.25MHz, or 1618.75MHz
- GPS/Satellite antenna gain +1.06 dBi
- Wireless antenna: 0dBm TX power / -69dBm RX sensitivity
- Wireless antenna gain: -1.09 dBi

## Battery Specifications

The GSatSolar Series is configured at the factory to cut off charging at temperatures below -10°C and above 65°C.

Battery Chemistry: Lithium Polymer

Battery Capacity: 153mAh

Battery Lithium Content: 0.054 grams

Battery Specifications	Min	Typical	Max	Unit
Rated Capacity @ 4.2V		153		mAh
Normal Voltage		3.7		V
Maximum Charge Voltage		4.2		V
Maximum Discharge Voltage		3.0		V
Charging Current - Standard Charge		0.2		C
Charging Current - Rapid Charge		1.0		C
Charging Time - Standard Charge	5.5		6.5	hours
Charging Time - Rapid Charge	1.5		2.5	hours
Maximum Charging Current		1.0		C

Discharge Temperature - Standard Discharge @ 0.2C	-20		+80	°C
Discharge Temperature - Rapid Discharge @ 1.0C	-20		+60	°C
Cell Impedance (4.2V AC @ 1khz)	255			mOhm
Cell Dimensions	(thickness) 4.0	(width) 14.0	(height) 30.0	mm

## Solar Panel Performance

Solar panels will generate about 10 to 25% of their normal power output on a cloudy day

Solar panels not oriented towards the sun will generate significantly less power. Orientation of the solar panel towards the sky will greatly increase reliable reporting rates during poor weather conditions or other obstructions during the lifetime of the unit.

Solar Panel Power: 125 mW

Charging Time:

- 5 hours of direct sunlight to fully charge from a dead battery
- 3 hours of direct daily sunlight to keep fully charged at 30-minute reporting rate

## Battery Performance

The ST100 battery performance heavily depends on the amount of GPS and Satellite Transmitter usage. Below are some examples of battery performance for select battery sizes and track modes.

Reporting Rate	Expected Battery Life (without charging the battery)
30 minutes / 48 per day	1.5 days
1 hour / 24 per day	3 days
4 hours / 6 per day	10 days
6 hours / 4 per day	14 days
12 hours / 2 per day	19 days
24 hours / 1 per day	28 days

NOTE: The data gathered above represents messages with a size of 1 data packet.

## GPS Performance

Chipset: ZOE-M8

Receiver type: 72-channel

- GPS/QZSS L1 C/A
- GLONASS L10F
- BeiDou B1I
- Galileo E1B/C

SBAS L1 C/A: WAAS, EGNOS, MSAS, GAGAN

Accuracy: 2.0 m CEP

#### Acquisition

- Cold starts: 26 s
- Aided starts: 2 s
- Reacquisition: 1 s

#### Sensitivity

- Tracking & Nav: -167 dBm
- Cold starts: -148 dBm
- Hot starts: -157 dBm

#### Anti-jamming

Active CW detection and removal

Onboard SAW bandpass filter

## Flash Memory

The GSatSolar Series utilizes internal flash to log position data over the life of the unit. The following specs detail the storage capacity. Depending on the reporting rate of the unit, you can formulate how many positions are stored onboard the device for logging.

#### Location Logging

- Size of each data element: 12 Bytes (3 for Lat, 3 for Long, 4 for Timestamp & 2 bytes padding)
- Total number of data elements: 8.4 (years) \* 365 (days) \* 4 (Tx per day) = 12276 data points

To determine how many days of locations are logged to the unit, use the following formula:

- $12276 / (\text{reports per day}) = (\text{number of days logging})$

## Material Specifications and Certifications

The following specifications are for the plastic case, and plastic clip:

**UL UV F1 Standard:** The GSatSolar Series is manufactured using UL F1-rated resin which is excellent for UV resistance in outdoor applications. The UL F1 rating meets industry standards for long-term UV exposure, making the housings suitable for outside applications where parts are subject to frequent or extended periods of exposure to sunlight.

For more information on the UL Solutions Yellow Card Plastics Recognition Program see: [www.ul.com](http://www.ul.com)

(F1) – Suitable for outdoor use concerning exposure to Ultraviolet Light, Water Exposure, and Immersion by UL 746C.

Property	Test Method	Value
<b>PHYSICAL PROPERTIES</b>		
UV Exposure & Water Immersion	UL 746C	F1
Dimensional Change	ASTM D1042/ISO2796	0.0%
Glow Wire Ignition Temperature (GWIT)	IEC 60695-2-13	825°C
Glow Wire Flammability Index (GWFI)	IEC 60695-2-12	960°C

Hot-wire Ignition (HWI)	UL 746A	PLC 2
High Amp Arc Ignition (HAI)	UL 746A	PLC 1
Comparative Tracking Index (CTI)	UL 746A	PLC 3
Dielectric Strength	ASTM D149	25 kV/mm
Inclined-Plane Tracking (IPT)	ASTM D2303	1.5 kV
Volume Resistivity	ASTM D257/IEC60093	1.0E+17 ohms/cm
Relative Thermal Index - Electrical Strength	UL 746B	125°C
Relative Thermal Index - Mechanical Impact	UL 746B	110°C
Relative Thermal Index - Mechanical Strength	UL 746B	120°C
<b>Izod Impact</b>		
notched 63.5x12.7x3.2, 23°C	ISO 180/4A	80 kJ/m <sup>2</sup>
notched 63.5x12.7x3.2, -30°C	ISO 180/4A	65 kJ/m <sup>2</sup>
Charpy 23°C, V-notch Edgew 80x103 sp=62mm	ISO 179/1eA	75 kJ/m <sup>2</sup>
Charpy -30°C, V-notch Edgew 80x103 sp=62mm	ISO 179/1eA	60 kJ/m <sup>2</sup>
<b>Tensile</b>		
Stress, yld, Type I, 50 mm/min	ASTM D638	58 MPa
Stress, brk, Type I, 50 mm/min	ASTM D638	61 MPa
Strain, yld, Type I, 50 mm/min	ASTM D638	6%
Strain, brk, Type I, 50 mm/min	ASTM D638	130%
Modulus, 50 mm/min	ASTM D638	2100 MPa
<b>Flexural</b>		
Stress, yld, 1.3 mm/min, 50 mm span	ASTM D790	88 MPa
Modulus, 1.3 mm/min, 50 mm span	ASTM D790	2060 MPa
Stress, yield, 50 mm/min	ISO 527	55 MPa
Stress, break, 50 mm/min	ISO 527	60 MPa
Strain, yield, 50 mm/min	ISO 527	6%
Strain, break, 50 mm/min	ISO 527	125%
Modulus, 1 mm/min	ISO 527	2100 MPa

Stress, yield, 2 mm/min	ISO 178	85 MPa
Modulus, 2 mm/min	ISO 178	2200 MPa
<b>IMPACT</b>		
Izod Impact, notched, 23°C	ASTM D256	801 J/m
Izod Impact, notched, -30°C	ASTM D256	678 J/m
Izod Impact, notched, -50°C	ASTM D256	587 J/m
Izod Impact, notched, 23°C, 6.4mm	ASTM D256	640 J/m
Instrumented Dart Impact Total Energy, 23°C	ASTM D3763	52 J
Izod Impact, notched 80x103 +23°C	ISO 180/1A	70 kJ/m <sup>2</sup>
Izod Impact, notched 80x103 -30°C	ISO 180/1A	55 kJ/m <sup>2</sup>
<b>Vicat Softening Temp</b>		
Rate B/50	ASTM D1525	142 °C
<b>HDT</b>		
0.45 MPa, 3.2 mm, unannealed	ASTM D648	134 °C
1.82 MPa, 3.2 mm, unannealed	ASTM D648	120 °C
1.82 MPa, 6.4 mm, unannealed	ASTM D648	124 °C
<b>CTE</b>		
-40°C to 40°C, flow	ASTM E831	6.66E-05 1/°C
-40°C to 40°C, xflow	ASTM E831	6.66E-05 1/°C
23°C to 80°C, flow	ISO 11359-2	7.2E-05 1/°C
23°C to 80°C, xflow	ISO 11359-2	7.7E-05 1/°C
<b>Ball Pressure Test</b>		
125°C +/- 2°C	IEC 60695-10-2	PASSES
<b>ISO/IEC FLAMMABILITY PROPERTIES</b>		
Flammability	IEC 60695-11-10	V-0
<b>Ball Indentation Hardness</b>		
H358/30	ISO 2039-1	90 MPa
<b>PHYSICAL</b>		
Specific Gravity	ASTM D792	1.18



Density	ISO 1183	1.19 g/cm <sup>3</sup>
Water Absorption, (23°C/saturated)	ISO 62-1	0.35%
Moisture Absorption (23°C / 50% RH)	ISO 62	0.15%

## Other Specifications

Harmonized Code: 8526.91.0040

## General Warnings

**WARNING** – Modifications: Changes or modifications to the GSatSolar Series not expressly approved by the party responsible for compliance could void the user’s authority to operate the equipment.

**WARNING** – Blasting Area: To avoid interference with blasting operations, turn your GSatSolar off when in a “Blasting Area” or in areas posted “Turn off two-way radio.” Obey all signs and instructions.

**WARNING** – Potential Explosive Atmosphere: Turn off the GSatSolar Series when in any area with a potentially explosive atmosphere and obey all signs and instructions.

**WARNING** – Pacemakers: The Health Industry Manufacturers Association recommends that a minimum separation of six (6”) inches be maintained between the GSatSolar Series and a pacemaker to avoid potential interference with the pacemaker.

**WARNING** – Hearing Aids: Some digital wireless devices may interfere with some hearing aids. To prevent such interference, you may want to consult the manufacturer of your hearing aid.

**WARNING** – Specific Absorption Rate (SAR):

FCC / Canada: The GSatSolar Series is compliant with localized Specific Absorption Rate (SAR) for uncontrolled environment/ general exposure limits specified in ANSI/IEEE STD C95.1-1992 and has been tested by measurement procedure specified in IEEE 1528-2013 and IEC 62209-2:2010 using a separation distance of 20 cm.

European Union (CE RED): The GSatSolar Series is compliant with localized specific absorption rate (SAR) for uncontrolled environment / general exposure limits specified in ANSI/IEEE Std. C95.1-1999 and has been tested by the measurement procedures specified in EN50566:2017 and EN62209-2:2010 using a separation distance of 20 cm.

**NOTE:** If concerned about RF exposure during use, place the GSatSolar Series away from your body. The RF exposure level drops off dramatically with distance from the GSatSolar Series.

## Product Maturing

 **NOTE:** As the unit ages and is exposed to UV radiation, there will be some slight yellowing that occurs with the plastic case. The yellowing has a minimal effect on the performance of the unit or the strength of the plastic. The plastic is UL F1 rated, which is part of UL 746. This test specifies a 1,000 hr accelerated UV plus high-temperature water exposure test to qualify polymer enclosures for outdoor industrial use.

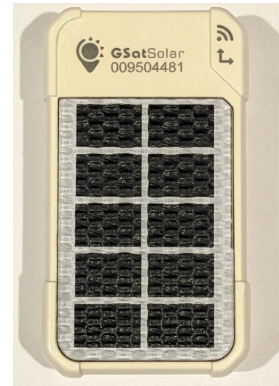

# Regulatory

## Radio Astronomy Site Avoidance

The GSatSolar Series complies with FCC CFR25.213. The customer end-product must comply with the requirements for Radio Astronomy avoidance. See Globalstar document GS-07-1248 REMOTE TELEMETRY SERVICE FREQUENCY PLAN FOR SIMPLEX TRANSMITTERS for more details

## Regulatory Notices

The GSatSolar Series has received Federal Communications Commission authorization under FCC Rules Part 25 and Part 15C as a modular transmitter. The final installation must comply with 25.213 (see above). The installation and operating configurations of this transmitter must satisfy MPE categorical Exclusion Requirements of 2.1091. The antenna used for this transmitter must be installed to provide a separation distance of at least 20 cm from all persons and must not be collocated or operating in conjunction with any other antenna or transmitter.

The GSatSolar Series transmitter is only FCC-authorized for the specific rule parts (i.e., FCC transmitter rules) listed on the grant.

NOTE: Any additional host device the module is integrated into will require regulatory testing and certification (C2PC for FCC and C4PC for ISED\*\*).

The GSatSolar Series module has been labeled with its FCC ID numbers as follows:

Contains Transmitter Module FCC ID: L2V-ST100 IC: 3989AST100  
This device complies with Part 15 of the FCC Rules. Operation is subject to the following two conditions: (1) this device may not cause harmful interference, and (2) this device must accept any interference received, including interference that may cause undesired operation.

## Additional Notices

This equipment has been tested and found to comply with the limits for a Class B digital device, pursuant to part 15 of the FCC Rules. These limits are designed to provide reasonable protection against harmful interference in a residential installation. This equipment generates, uses, and can radiate radio frequency energy, and if not installed and used in accordance with the instructions, may cause harmful interference to radio communications. However, there is no guarantee that interference will not occur in a particular installation. If this equipment does cause harmful interference to radio or television reception, which can be determined by turning the equipment OFF and ON, the user is encouraged to try to correct the interference by one or more of the following measures:

- Reorient or relocate the receiving antenna.
- Increase the separation between the equipment and receiver.
- Connect the equipment to an outlet on a circuit different from that to which the receiver is connected.
- Consult the dealer or an experienced radio/TV technician for help.

**WARNING:** Changes or modifications not expressly approved by Globalstar may render the device non-compliant to FCC and other regulatory body standards for operation and may void the user's authority to operate the equipment.

This device complies with Part 15 of the FCC Rules. Operation is subject to the following two conditions: (1) This device may not cause harmful interference, and (2) this device must accept any interference received, including interference that may cause undesired operation.

\*\*ISED is an acronym for Innovation, Science and Economic Development (Canada).

This Class B digital apparatus complies with Canadian ICES-003.

Cet appareil numérique de classe B est conforme à la norme NMB-003.

Hereby, Global Satellite Engineering declares that this GSatSolar is in compliance with the essential requirements and other relevant provisions of Directive 2014/53/EU. The declaration of conformity may be consulted at [www.Globalstar.com/Regulatory](http://www.Globalstar.com/Regulatory).

NOTICE: This equipment complies with FCC, IC, and CE RF Exposure Limits. A minimum of 20 centimeters (8 inches) separation between the device and the user and all other persons should be maintained.

AVIS: Cet équipement est conforme aux RSS-102 Limites d'exposition RF. Un minimum de 20 centimètres (8 pouces) entre l'appareil et l'utilisateur et toutes les autres personnes devrait être maintenue.

Transmit Frequencies: 1611.25 Mhz - 1618.75 Mhz (4 Channels) Max Power Out: 25.82 dBm EIRP

FCC ID: L2V-ST100  
CAN ICES-3(B)/NMB-3B  
IC: 3989A-ST100  
Complies with FCC standards.  
FOR HOME OR OFFICE USE

The GSatSolar Series has been so constructed that the product complies with the requirement of Article 10(2) as it can be operated in at least one Member State as examined and the product is compliant with Article 10(10) as it has no restrictions on being put into service in all of the EU except Ireland. The GSatSolar Series cannot be marketed in Ireland.

# Appendix A

## Acronym List

ACK: Acknowledgement  
APP: Application  
ASCII: American Standard Code for Information Interchange  
ASIC: Application-Specific Integrated Circuit  
C: Celsius  
CE RED: Conformité Européene Radio Equipment Directive (Europe)  
CPU: Central Processing Unit  
CRC: Cyclic Redundancy Check  
dBm: Decibel-Milliwatts  
DC: Direct Current  
DFU: Device Firmware Update  
EIRP: Effective, or Equivalent, Isotropically Radiated Power  
ESD: Electrostatic Discharge  
ESN: Electronic Serial Number  
F: Fahrenheit  
FCC: Federal Communications Commission  
FTP: File Transfer Protocol  
GATT: Generic Attribute Profile  
GLONASS: Global Navigation Satellite System  
GND: Ground  
GPIO: General-Purpose Input/Output  
GPS: Global Positioning System  
HTTP: Hypertext Transfer Protocol  
HW: Hardware  
I2C: Inter-Integrated Circuit  
IC: Industry Canada  
iOS: iPhone Operating System  
ISED: Innovation, Science and Economic Development (Canada)  
JTAG: Joint Test Action Group  
LEO: Low Earth Orbiting  
mA: Milliamps  
mAh: Milliamp Hour  
mm: millimeter  
mW: milliwatt  
N/A: Not Applicable  
NAK: Negative-Acknowledgement  
NMEA: National Marine Electronics Association

OEM: Original Equipment Manufacturer  
OTA: Over the Air  
PCB: Printed Circuit Board  
PLL: Phase-Locked Loop  
POST: Power-On Self-Test  
RF: Radio Frequency  
RoHS: Restriction of Hazardous Substances  
RTU: Remote Transmitter Unit  
RX: Receive  
SAR: Specific Absorption Rate  
SCL: Serial Clock  
SDA: Serial Data  
SDK: Software Development Kit  
SMA: Subminiature Version A  
STU: Satellite Transmitter Unit  
TX: Transmit  
UART: Universal Asynchronous Receiver/Transmitter  
V: Volts  
VAM: Value Added Manufacturer  
VAR: Value Added Reseller  
VDC: Voltage Direct Current  
VNA: Vector Network Analyzer  
WEEE: Waste Electrical & Electronic Equipment (Europe)